

# COMFORT

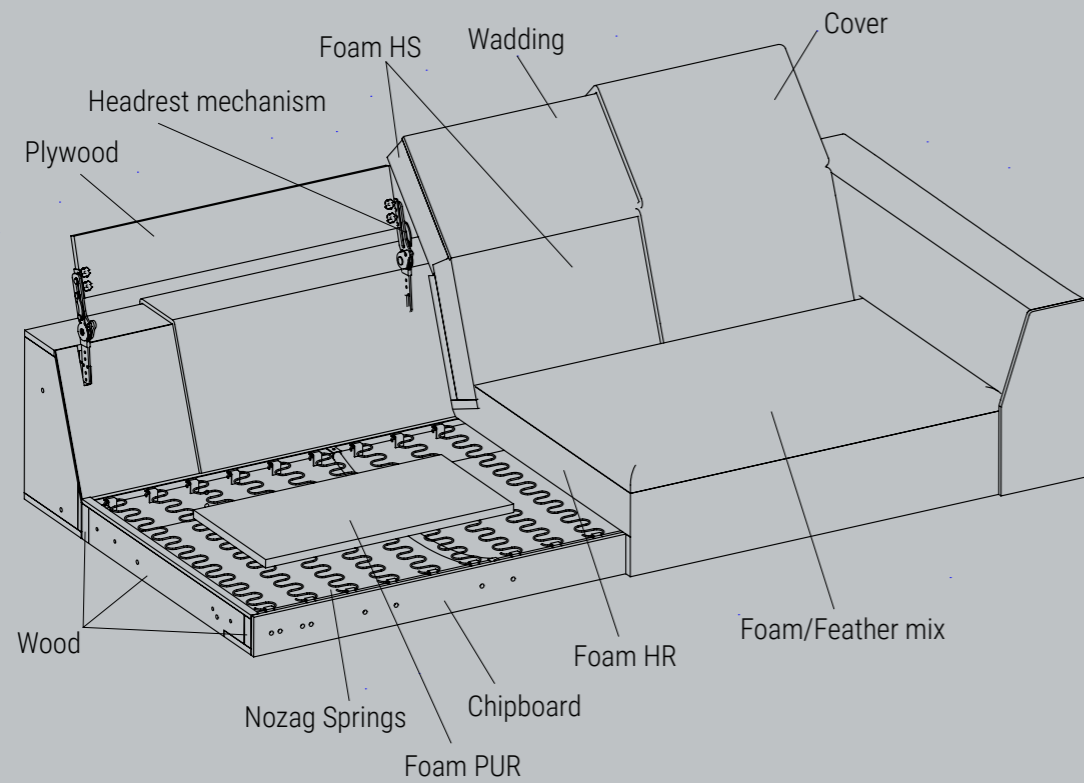

# VOLLUZZI

Volluzzi is Italian inspired sophistication! This sofa offers manually adjustable head rests for each seat for additional neck support. The back and seat cushions are fixed. The back cushions are made with hyper-soft foam and cut with special 3D technology to achieve the best comfort and durability. The arms have soft rounded shapes that contribute to the elegance of this sofa. Volluzzi is built on a strong metal frame. We offer optional lumbar cushions for even more support. The sofa is available with new organic shaped black metal legs that fit the sofa beautifully.



## DESIGN ELEMENTS

14 Combinations  
Available in fabric and leather

## HOW TO DESIGN

1. Choose design 340
2. Choose combination
3. Choose fabric or leather
4. Legs included



THECA A/S - WWW.THECA.DK

THECA reserves the right to modify or delete prices, products and product specifications without any prior notice. THECA has no liability for any errors or omissions in the materials. All weights and measures shown are best approximations. Seams and stitching can vary from fabric to leather.

WWW.THECA.DK

**THECA**  
Danish Comfort.

Combination **3221**

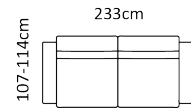

3-seater

Combination **2221**

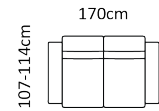

2-seater

Combination **1760**

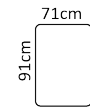

Foot rest

Combo shown  
Combo mirrored **0011  
0021**

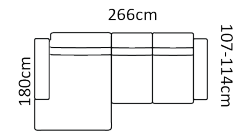

Chaiselong+2-seater

Combo shown  
Combo mirrored **0031  
0041**

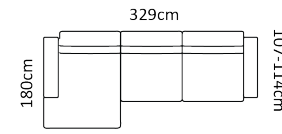

Chaiselong+3-seater

Combo shown  
Combo mirrored **0051  
0061**

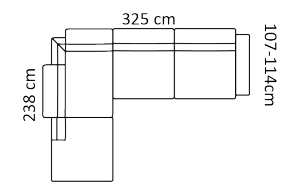

Open-end+3-seater

Combo shown  
Combo mirrored **0071  
0081**

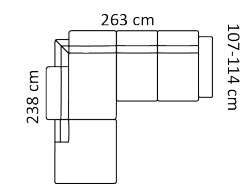

Open-end+2-seater

**Price group**

1	M3: 1,66
2	.....
3	.....
4	.....
5	.....
Eton w. Split	.....
Eton	.....
Savoy / split	.....
Savoy	.....
Safari	.....
Nature	.....
Vintage	.....

M3: 1,22
.....
.....
.....
.....
.....
.....
.....
.....
.....
.....

M3: 0,22
.....
.....
.....
.....
.....
.....
.....
.....
.....
.....

M3: 2,4
.....
.....
.....
.....
.....
.....
.....
.....
.....
.....

M3: 2,85
.....
.....
.....
.....
.....
.....
.....
.....
.....
.....

M3: 3,21
.....
.....
.....
.....
.....
.....
.....
.....
.....
.....

M3: 2,76
.....
.....
.....
.....
.....
.....
.....
.....
.....
.....

Deco cushion **0058**

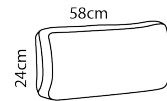

Deco cushion **0088**

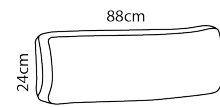

**Price group**

1	M3: 0,05
2	.....
3	.....
4	.....
5	.....
Eton w. Split	.....
Eton	.....
Savoy / split	.....
Savoy	.....
Safari	.....
Nature	.....
Vintage	.....

M3: 0,05
.....
.....
.....
.....
.....
.....
.....
.....
.....
.....

n.a.: not available

With a nominal size of up to 150 cm. (width, depth, height), the tolerance may not exceed 2 cm.  
When larger than 150 cm, not more than 2,5 cm.